



TFA9871_SDS

High Efficiency Class-D Audio Amplifier

Version: 2.0

Release Date: 2020-01-21

Contents

1	General description.....	1
2	Features and benefits.....	2
3	Applications.....	3
4	Quick reference data.....	4
5	Ordering information.....	6
6	Block diagram.....	7
7	Pinning information.....	8
	7.1 Pinning.....	8
8	Functional description.....	11
9	Limiting values.....	12
10	Thermal characteristics.....	13
11	Characteristics.....	14
	11.1 DC characteristics.....	14
	11.2 AC characteristics.....	15
	11.3 TDM timing characteristics.....	18
	11.4 I ² C timing characteristics.....	19
12	Application information.....	21
	12.1 Application diagrams.....	21
13	Package outline.....	23
14	Soldering of WLCSP packages.....	24
	14.1 Introduction to soldering WLCSP packages.....	24
	14.2 Board mounting.....	24
	14.3 Reflow soldering.....	24
	14.3.1 Stand off.....	25
	14.3.2 Quality of solder joint.....	25
	14.3.3 Rework.....	25
	14.3.4 Cleaning.....	26
15	Legal and contact information.....	27
16	Revision history.....	28

1 General description

The TFA9871 is a high efficiency 8.5 V boosted class-D audio amplifier. It can deliver up to 8 W peak output power into an 8 Ω speaker and up to 10 W peak output power into a 6 Ω speaker, at a supply voltage of 4.0 V. The internal adaptive DC-to-DC converter raises the supply voltage up to 8.5 V, providing ample headroom for major improvements in sound quality.

Internal adaptive DC-to-DC conversion boosts the supply rail to provide additional headroom and power output. The supply voltage is only raised when necessary. This maximizes the output power of the class-D audio amplifier while limiting quiescent power consumption.

The device can be configured to drive either a hands-free speaker (4 Ω to 8 Ω) for audio playback, or a receiver speaker (32 Ω), for handset playback, allowing it to be embedded in platforms supporting both a hands-free speaker and a handset speaker. The maximum output power and the noise levels are lower in handset call use case than in hands-free call use case.

The TFA9871 also incorporates battery protection. By limiting the supply current when the battery voltage is low, it prevents the audio system from drawing excessive load currents from the battery, which could cause a system under voltage. This circuitry minimizes the impact of a falling battery voltage by preventing unexpected device switch off due to excessive current drawn from the battery.

The device features low RF susceptibility because it has a digital input interface that is insensitive to clock jitter. The second order closed loop architecture used in a class-D audio amplifier provides excellent audio performance and high supply voltage ripple rejection. The audio input interface is TDM and the control settings are communicated via an I²C-bus interface.

The TFA9871 is available in a 36-bump WLCSP (Wafer Level Chip-Size Package) with a 400 μm pitch.

2 Features and benefits

- High output power: 4.1 W (average) into 8 Ω at 4.0 V supply voltage (THD = 1 %)
- Supports handset (16 Ω or 32 Ω) and hands-free (4 Ω to 8 Ω) speaker configurations
- High efficiency, low power dissipation and low-noise speaker driver
- Adaptive DC-to-DC converter increases the supply voltage smoothly when switching between Fixed Boost and Adaptive Boost modes, preventing large battery supply spikes and limiting quiescent power consumption
- Wide supply voltage range (fully operational from 2.7 V to 5.5 V)
- Very low noise output voltage <15 μ V with -60 dBFS input at $f_s = 48$ kHz)
- Low battery current consumption <118 mA ($P_o = 380$ mW, average music power)
- I²C-bus control interface (400 kHz)
- Speaker current and voltage monitoring (via the TDM-bus) for Acoustic Echo Cancellation (AEC) at the host
- 16 kHz/32 kHz/44.1 kHz/48 kHz sample frequencies supported
- Ultrasonic support via TDM running at 96 kHz
- Programmable interrupt control via a dedicated interrupt pin
- Low RF susceptibility
- Thermal foldback and overtemperature protection
- 15 kV system-level ESD protection without external components on amplifier output

3 Applications

- Mobile phones and Tablets
- Portable Navigation Devices (PND)
- Notebooks/Netbooks
- Internet of Things applications embedding high quality audio

4 Quick reference data

Table 4-1: Quick reference data

Symbol	Parameter	Conditions	Min	Typ	Max	Unit
V_{BAT}	battery supply voltage	on pin VBAT V_{BAT} must not be lower than V_{DDD} in application	2.7	-	5.5	V
V_{DDD}	digital supply voltage	on pin VDDD	1.65	1.8	1.95	V
V_{DDP}	power supply voltage	on pin VDDP	2.7	-	8.5	V
R_L	load resistance		3.2	-	38	Ω
I_{BAT}	battery supply current	Active state on pin VBAT; Operating mode with load $R_L = 6 \Omega$; DC-to-DC in Adaptive Boost mode; $P_o = 380$ mW, (average music power), $V_{BAT} = 4.0$ V; $V_{DDP} = 8.5$ V	-	120	-	mA
		Idle state on pin VBAT; Operating mode with load $R_L = 6 \Omega$; DC-to-DC in Adaptive Boost mode; $P_o = 0$ mW; $V_{BAT} = 4.0$ V; $V_{DDP} = 8.5$ V	-	2.5	-	mA
		Power-down state	-	1	-	μ A
I_{DDD}	digital supply current	Active state on pin VDDD; Operating mode with load $R_L = 6 \Omega$; DC-to-DC in Adaptive Boost mode; $P_o = 380$ mW, (average music power), $V_{BAT} = 4.0$ V; $V_{DDP} = 8.5$ V	-	5.2	-	mA
		Idle state on pin VDDD; Operating mode with load $R_L = 6 \Omega$; DC-to-DC in Adaptive Boost mode; $P_o = 0$ mW; $V_{BAT} = 4.0$ V; $V_{DDP} = 8.5$ V	-	3.6	-	mA
		Power-down state	-	10	-	μ A
$P_{o(AV)}$	average output power	THD+N = 1 %; ($R_L = 8 \Omega$; $L_L = 44 \mu$ H); $V_{BST} = 8.5$ V; $V_{BAT} = 4.0$ V; $V_{DDD} = 1.8$ V	-	4.1	-	W

Symbol	Parameter	Conditions	Min	Typ	Max	Unit
		THD+N = 1 %; ($R_L = 6 \Omega$; $L_L = 44 \mu\text{H}$); $V_{\text{BST}} = 8.5 \text{ V}$; $V_{\text{BAT}} = 4.0 \text{ V}$; $V_{\text{DDD}} = 1.8 \text{ V}$	-	5.1	-	W

5 Ordering information

Table 5-1: Ordering information

Type number	Package		
	Name	Description	Version
TFA9871UK/N1	WLCSP36	wafer level chip-scale package; 36 bumps; 0.4 mm pitch, 2.62 mm × 2.51 mm × 0.5 mm;	SOT1780-5

6 Block diagram

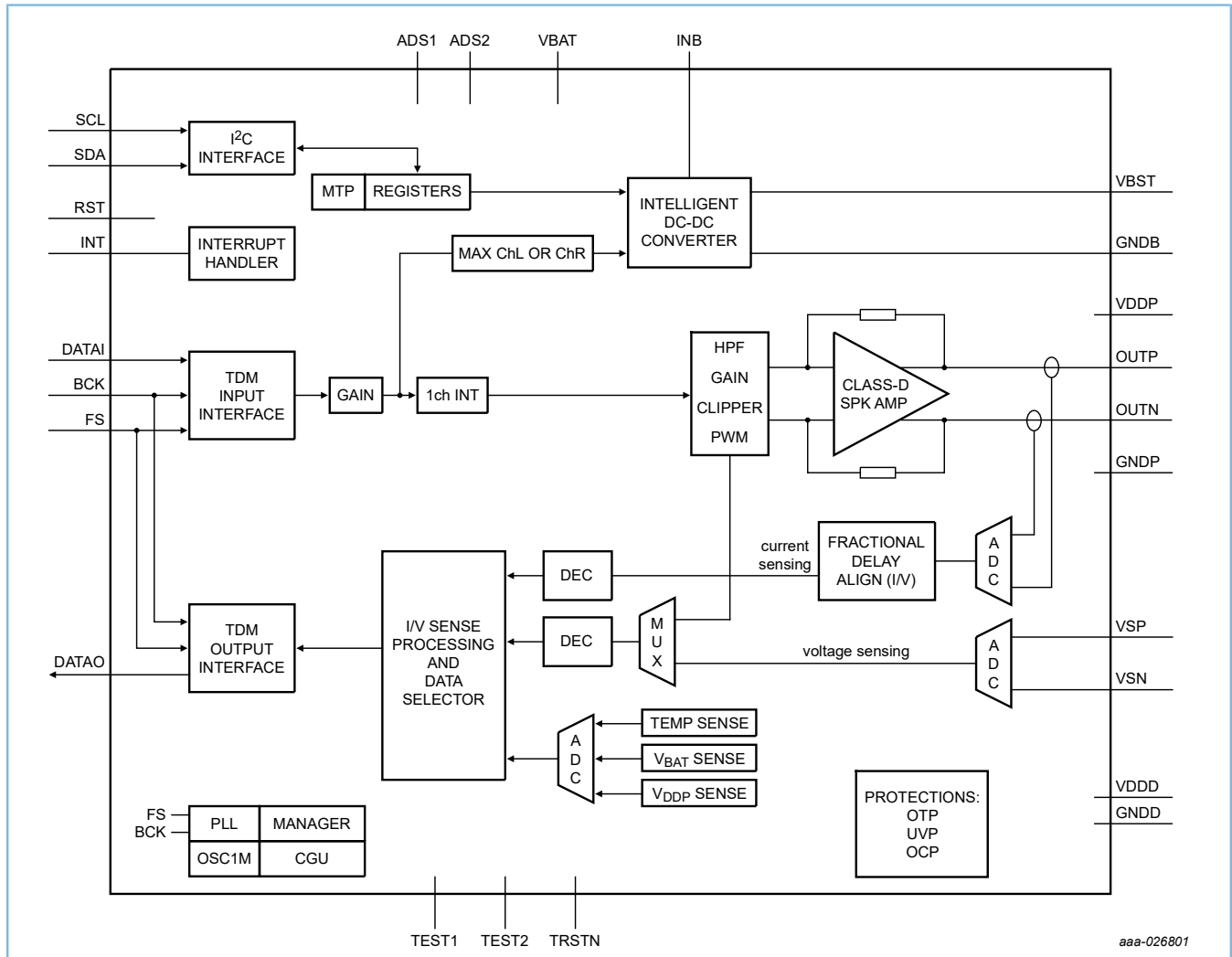

Figure 6-1: Block diagram

7 Pinning information

7.1 Pinning

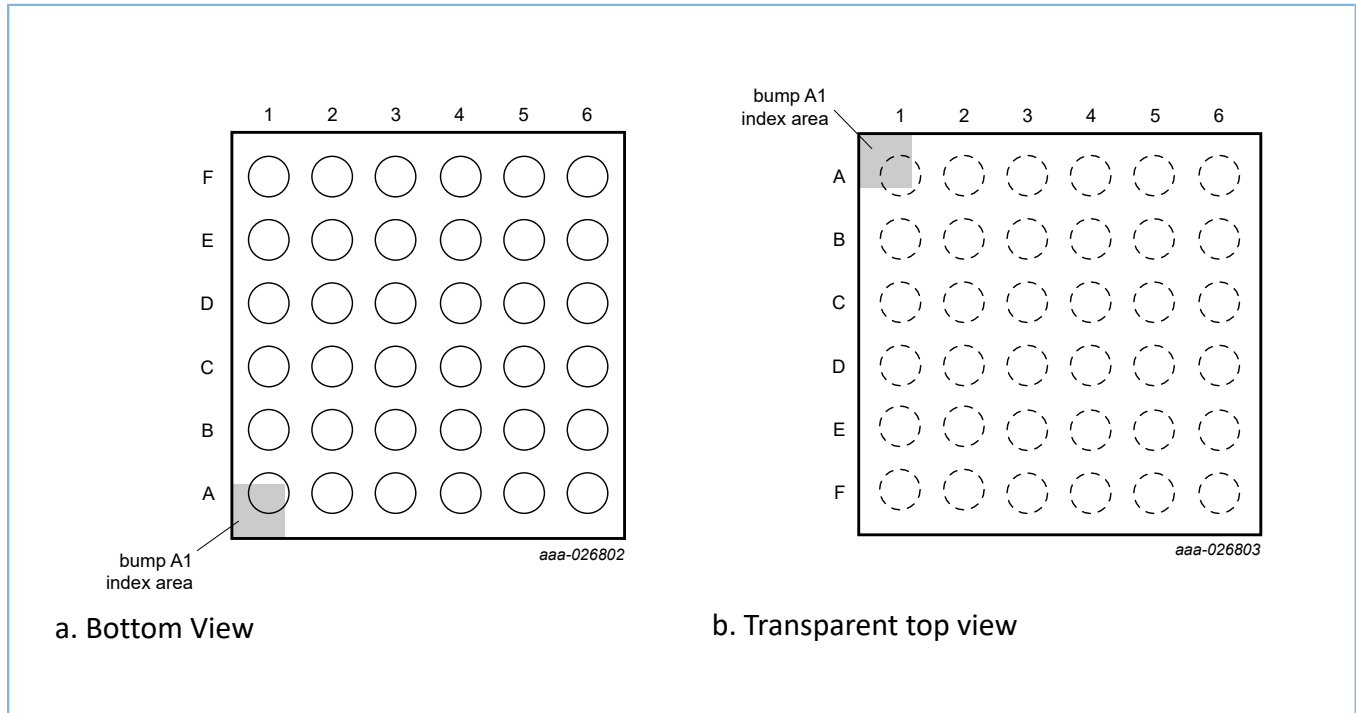

Figure 7-1: Bump configuration

	1	2	3	4	5	6
A	BCK	FS	VDDD	SCL	SDA	TRSTN
B	DATAO	DATAI	ADS2	ADS1	INT	VBAT
C	RST	GNDD	VSN	TEST2	TEST1	VSP
D	GNDB	GNDB	GNDB	GNDD	GNDP	GNDD
E	INB	INB	INB	OUTP	GNDP	OUTN
F	VBST	VBST	VBST	VDDP	VDDP	VDDP

Transparent top view

aaa-030120

Figure 7-2: Bump mapping

Table 7-1: Pinning

Symbol	Pin	Type	Description
BCK	A1	I	digital audio bit clock input for TDM interface
FS	A2	I	digital audio frame sync input for TDM interface
VDDD	A3	I	digital supply voltage

Symbol	Pin	Type	Description
SCL	A4	I	digital I ² C-bus clock input
SDA	A5	I/O	digital I ² C-bus data input/output
TRSTN	A6	I	test signal input TRSTN, connect to PCB ground
DATAO	B1	I/O	digital audio data output for TDM interface
DATAI	B2	I	digital audio data input for TDM interface
ADS2	B3	I	digital address select input 2
ADS1	B4	I	digital address select input 1
INT	B5	O	digital interrupt output
VBAT	B6	P	battery supply voltage
RST	C1	I	reset input
GNDD	C2	P	digital ground
VSN	C3	I/O	voltage sense negative input
TEST2	C4	I/O	test signal input 2; for test purposes only; connect to PCB ground, or connect via a capacitor to PCB ground
TEST1	C5	I/O	test signal input 1; for test purposes only; connect to PCB ground, or connect via a capacitor to PCB ground input
VSP	C6	I/O	voltage sense positive
GNDB	D1	P	boosted ground
GNDB	D2	P	boosted ground
GNDB	D3	P	boosted ground
GNDD	D4	P	digital ground
GNDP	D5	P	power ground
GNDD	D6	P	digital ground
INB	E1	P	DC-to-DC boost converter input
INB	E2	P	DC-to-DC boost converter input
INB	E3	P	DC-to-DC boost converter input
OUTP	E4	O	non-inverting output
GNDP	E5	P	power ground
OUTN	E6	O	inverting output

Symbol	Pin	Type	Description
VBST	F1	O	boosted supply voltage output
VBST	F2	O	boosted supply voltage output
VBST	F3	O	boosted supply voltage output
VDDP	F4	P	power supply voltage
VDDP	F5	P	power supply voltage
VDDP	F6	P	power supply voltage

8 Functional description

The TFA9871 is a highly efficient Bridge Tied Load (BTL) class-D audio amplifier as depicted in block diagram (see [Figure 6-1](#)).

TFA9871 contains a TDM input/output interface for communicating with the audio host. It also offers the possibility of providing an ultrasonic path to the speaker.

At low battery voltage levels, the gain (from TDM interface to speaker output) is automatically reduced to limit battery current (when battery safeguard is enabled).

The digital audio stream is converted into two Pulse Width Modulated (PWM) signals which are then injected into the class-D audio amplifier. The 3-level PWM scheme supports filterless speaker drive.

An adaptive DC-to-DC converter boosts the output voltage to the level that is required by the ClassD amplifier.

9 Limiting values

Table 9-1: Limiting values

In accordance with the Absolute Maximum Rating System (IEC 60134).

Symbol	Parameter	Conditions	Min	Typ	Max	Unit
V _{BAT}	battery supply voltage	on pin VBAT	-0.3	-	+6	V
V _{BST}	booster output voltage	on pin VBST	^[1] -0.3	-	+12	V
V _{INB}	booster input voltage	on pin INB	^[1] -0.3	-	+12	V
V _{DDP}	power supply voltage	on pin VDDP	^[1] -0.3	-	+12	V
V _O	output voltage	on speaker connections; pins OUTP, OUTN	^[1] -0.3	-	+12	V
V _{DDD}	digital supply voltage	on pin VDDD	-0.3	-	+2.5	V
V _{low}	low voltage	on pins TEST1/TEST2	-0.3	-	+2.5	V
T _j	junction temperature		-	-	+125	°C
T _{stg}	storage temperature		-55	-	+150	°C
T _{amb}	ambient temperature		-40	-	+85	°C
V _{ESD}	electrostatic discharge voltage	according to Human Body Model (HBM)	-2	-	+2	kV
		according to Charge Device Model (CDM)	-500	-	+500	V

[1] Using Goodix demo board, with a 1 mm wire/PCB track length on INB pin, AC pulse up to 15 V can be observed, without damaging the device as these spikes do not end up inside the actual device.

10 Thermal characteristics

Table 10-1: Thermal characteristics

Symbol	Parameter	Conditions	Typ	Max	Unit
$R_{th(j-a)}$	thermal resistance from junction to ambient	4-layer application board	40	-	K/W

11 Characteristics

11.1 DC characteristics

Table 11-1: DC characteristics

All parameters are guaranteed for $V_{BAT} = 4.0\text{ V}$; $V_{DDD} = 1.8\text{ V}$; $V_{DDP} = V_{BST} = 8.5\text{ V}$, adaptive boost mode; $L_{BST} = 1\text{ }\mu\text{H}^{[1]}$; $R_L = 8\text{ }\Omega^{[1]}$; $L_L = 44\text{ }\mu\text{H}^{[1]}$; $f_i = 1\text{ kHz}$; $f_s = 48\text{ kHz}$; $T_{amb} = 25\text{ }^\circ\text{C}$; default settings, unless otherwise specified.

Symbol	Parameter	Conditions	Min	Typ	Max	Unit
V_{BAT}	battery supply voltage	on pin VBAT V_{BAT} must not be lower than V_{DDD}	2.7	-	5.5	V
I_{BAT}	battery supply current	Active state: On pin VBAT; Operating mode with load $R_L = 6\text{ }\Omega$; DC-to-DC in Adaptive Boost mode; $P_o = 380\text{ mW}$, (average music power),	-	120	-	mA
		Idle state: On pin VBAT; Operating mode with load $R_L = 6\text{ }\Omega$ and no output signal (idle); DC-to-DC converter in Adaptive Boost mode;	-	2.5	-	mA
		Power-down state: On pin VBAT; DC-to-DC in Power-down mode; $T_j = 25\text{ }^\circ\text{C}$; no clock	-	1	-	μA
V_{DDP}	power supply voltage	on pin VDDP	2.7	-	8.5	V
V_{DDD}	digital supply voltage	on pin VDDD	1.65	1.8	1.95	V
I_{DDD}	digital supply current	Active state	-	5.2	-	mA
		Idle state	-	3.6	-	mA
		Power-down state	-	10	-	μA
Pins FS, BCK, DATAI, ADS1, ADS2, SCL, SDA, RST, TRSTN						
V_{IH}	HIGH-level input voltage		$0.7V_{DDD}$	-	V_{DDD}	V
V_{IL}	LOW-level input voltage		-	-	$0.3V_{DDD}$	V
C_{in}	input capacitance		^[2] -	-	3	pF
I_{LI}	input leakage current	1.8 V on input pin	-	-	0.1	μA
Pins DATAO, INT, push-pull output stages						

Symbol	Parameter	Conditions	Min	Typ	Max	Unit
V _{OH}	HIGH-level output voltage	I _{OH} = 4 mA	V _{DD} - 0.4	-	-	V
V _{OL}	LOW-level output voltage	I _{OL} = 4 mA	-	-	400	mV
Pins SDA, open-drain outputs, external 10 kΩ resistor to V_{DD}						
V _{OH}	HIGH-level output voltage		V _{DD} - 0.4	-	-	V
V _{OL}	LOW-level output voltage	I _{OL} = 4 mA	-	-	400	mV
Pins OUTP, OUTN						
R _{DSon}	drain-source on-state resistance	PMOS+NMOS transistors	-	430	520	mΩ
Protection						
T _{act(th_prot)}	thermal protection activation temperature		130	-	-	°C
V _{ovp(VBAT)}	overvoltage protection on pin VBAT		5.6	-	6.0	V
V _{uvp(VBAT)}	undervoltage protection on pin VBAT		2.3	-	2.7	V
I _{O(ocp)}	overcurrent protection output current		2.5	-	-	A
DC-to-DC converter						
V _{BST}	voltage on pin VBST	DCVOS = 111111; Boost mode (after trim)	8.3	8.5	8.7	V

[1] L_{BST} = boost converter inductance; R_L = load resistance; L_L = load inductance (speaker).

[2] This parameter is not tested during production; the value is guaranteed by design and checked during product validation.

11.2 AC characteristics

Table 11-2: AC characteristics

All parameters are guaranteed for V_{BAT} = 4.0 V; V_{DD} = 1.8 V; V_{DDP} = V_{BST} = 8.5 V, adaptive boost mode; L_{BST} = 1 μH^[1]; R_L = 8 Ω^[1]; L_L = 44 μH^[1]; f_i = 1 kHz; f_s = 48 kHz; T_{amb} = 25 °C; default settings, unless otherwise specified.

Symbol	Parameter	Conditions	Min	Typ	Max	Unit
Amplifier output power						
P _{O(AV)}	average output power	Hands-free speaker, THD+N = 1 %				

Symbol	Parameter	Conditions	Min	Typ	Max	Unit	
		$R_L = 8 \Omega$; $f_s = 48 \text{ kHz}$	3.6	4.1	-	W	
		$R_L = 6 \Omega$; $f_s = 48 \text{ kHz}$	4.6	5.1	-	W	
		$R_L = 4 \Omega$; $f_s = 48 \text{ kHz}$	5.1	5.7	-	W	
		Receiver speaker. THD+N = 1 %;					
		$R_L = 32 \Omega$; Voice mode	-	0.2	-	W	
		$R_L = 32 \Omega$; Audio mode	-	1.1	-	W	
Amplifier output pins (OUTP and OUTN)							
$ V_{O(\text{offset})} $	output offset voltage	absolute value, after trimming; $V_{DDP} = 3.4 \text{ V}$ to 8.5 V , $V_{BAT} = 3.4 \text{ V}$ to 5 V	-	-	1.0	mV	
Amplifier performances							
η_{po}	output power efficiency	On pin VBAT; Operating mode with load $R_L = 6 \Omega$; DC-to-DC in Tracking Boost mode, $P_o = 380 \text{ mW}$, (average music power)	[2]	-	82	-	%
		On pin VBAT; input: 100 Hz sine wave, $R_L = 8 \Omega$; DC-to-DC in Tracking Boost mode, $P_o = 600 \text{ mW}$	[2]	-	91	-	%
		On pin VBAT; Input: 100 Hz sine wave, $R_L = 8 \Omega$; DC-to-DC in Adaptive Boost mode, $P_o = 3 \text{ W}$	[2]	-	84	-	%
THD+N	total harmonic distortion-plus-noise	$P_o = 2.0 \text{ W}$, $R_L = 8 \Omega$	[1]	-	-	0.05	%
		$P_o = 2.0 \text{ W}$, $R_L = 4 \Omega$	[1]	-	-	0.09	%
$V_{n(o)}$	output noise voltage	A-weighted; no input signal; Low Noise mode $f_s = 48 \text{ kHz}$	[2]	-	13	16	μV
		A-weighted; no input signal; Low Noise mode; $f_s = 16 \text{ kHz}$, 32 kHz	[2]	-	-	50	μV
		A-weighted; no input signal; Low Noise mode; $f_s = 44.1 \text{ kHz}$	[2]	-	15	18	μV

Symbol	Parameter	Conditions	Min	Typ	Max	Unit
DR	dynamic range	A-weighted, $V_{BAT} = 3.4\text{ V to }5\text{ V}$, $S/N = \text{maximum signal (at THD} = 1\text{ \%)}$; output noise voltage ($V_{n(o)}$); No signal applied	[2] 108	112	-	dB
S/N	signal-to-noise ratio	A-weighted, $V_{BAT} = 3.4\text{ V to }5\text{ V}$, maximum signal at THD = 1 %	[2] 100	-	-	dB
PSRR	power supply rejection ratio	from V_{BAT} ; booster in follower mode ($V_{DDP} = V_{BAT}$) $f_{ripple} = 217\text{ Hz square wave}$, $V_{ripple} = 50\text{ mV}_{(p-p)}$	60	80	-	dB
		from V_{BAT} ; booster in follower mode ($V_{DDP} = V_{BAT}$) $f_{ripple} = 20\text{ Hz to }1\text{ kHz sine wave}$, $V_{ripple} = 200\text{ mV (RMS)}$, $V_{BAT} = 3.4\text{ V to }5.0\text{ V}$ Low Power AND Low Noise modes on	60	80	-	dB
		from V_{BAT} ; booster in follower mode ($V_{DDP} = V_{BAT}$) $f_{ripple} = 1\text{ kHz to }20\text{ kHz sine wave}$, $V_{ripple} = 200\text{ mV (RMS)}$, $V_{BAT} = 3.4\text{ V to }5.0\text{ V}$	55	70	-	dB
$\Delta G/\Delta f$	gain variation with frequency	$BW = 20\text{ Hz to }15\text{ kHz}$, $V_{BAT} = 3.4\text{ V to }5\text{ V}$	-0.1	-	0.7	dB
V_{POP}	pop noise voltage	At mode transition and gain change.	-	-	2	mV
R_L	load resistance		3.2	8	38	Ω
C_L	load capacitance		-	-	200	pF
f_{sw}	switching frequency	directly coupled to the TDM input frequency	256	-	384	kHz
$G_{(TDM-V_O)}$	TDM to V_O gain	INPLEV = 0 dB	6	-	21	dB
Amplifier power-up, power-down and propagation delays						
$t_{d(on)PLL}$	PLL turn-on delay time	PLL locked on BCK, $f_s = 48\text{ kHz}$	-	2	-	ms

Symbol	Parameter	Conditions	Min	Typ	Max	Unit
$t_{d(on)amp}$	amplifier turn-on delay time	$f_s = 48 \text{ kHz}$	-	1	-	ms
$t_{d(off)}$	turn-off delay time		-	32	-	μs
$t_{d(alarm)}$	alarm delay time		-	200	-	ms
t_{PD}	propagation delay	$f_s = 16 \text{ kHz}$	-	-	850	μs
		$f_s = 32 \text{ kHz}$	-	-	750	μs
		$f_s = 44.1\text{kHz}$	-	-	650	μs
		$f_s = 48 \text{ kHz}$	-	-	700	μs
Booster Inductance						
L_{bst}	boost inductance		0.7	1.0	2.2	μH
Current-sensing performance						
$L_{L(spk)}$	speaker load inductance		30	-	-	μH
S/N	signal-to-noise ratio	$I_O = 1.1 \text{ A (peak)}$; A-weighted	62	65	-	dB
$\frac{\Delta V_{sense}}{I_{sense}}$	V_{sense}/I_{sense} ratio mismatch	Pilot tone -40 dBFS ^[3]	-	2	-	%
THD+N	total harmonic distortion-plus-noise	$f_i = 20 \text{ Hz to } 20 \text{ kHz}$, $V_i = -12 \text{ dBFS}$	-	-	0.75	%

[1] L_{BST} = boost converter inductor; R_L = load resistance; L_L = load inductance (speaker).
 [2] This parameter is not tested during production; the value is guaranteed by design and checked during product validation.
 [3] Intended for Speaker protection. In combination with Goodix speaker protection a speaker temperature accuracy of $\pm 10 \text{ }^\circ\text{C}$ can be realized

11.3 TDM timing characteristics

Table 11-3: TDM bus interface characteristics

All parameters are guaranteed for $V_{BAT} = 4.0 \text{ V}$; $V_{DDD} = 1.8 \text{ V}$; $V_{DDP} = V_{BST} = 8.5 \text{ V}$, adaptive boost mode; $L_{BST} = 1 \mu\text{H}^{[1]}$; $R_L = 8 \Omega^{[1]}$; $L_L = 44 \mu\text{H}^{[1]}$; $f_i = 1 \text{ kHz}$; $f_s = 48 \text{ kHz}$; $T_{amb} = 25 \text{ }^\circ\text{C}$; default settings, unless otherwise specified.

Symbol	Parameter	Conditions	Min	Typ	Max	Unit
f_s	sampling frequency	on pin WS, audio mode ^[2]	16	-	48	kHz
		on pin WS, ultrasonic mode	-	-	96	kHz
f_{clk}	clock frequency	on pin BCK, audio mode ^[2]	$32f_s$	-	$384f_s$	kHz
		on pin BCK, ultrasonic mode	-	-	$96f_s$	MHz
t_{su}	set-up time	WS edge to BCK HIGH ^[3]	10	-	-	ns

Symbol	Parameter	Conditions	Min	Typ	Max	Unit
		DATA edge to BCK HIGH	10	-	-	ns
t_h	hold time	BCK HIGH to WS edge ^[3]	10	-	-	ns
		BCK HIGH to DATA edge	10	-	-	ns
t_j	external clock jitter	PLL locked on BCK ^[4]	-	1	2	ns
		PLL locked on FS ^[5]	-	-	20	ns

[1] L_{BST} = boost converter inductance; R_L = load resistance; L_L = load inductance.

[2] The TDM bit clock input (BCK) is used as a clock input for the amplifier and the DC-to-DC converter. Note that both the BCK and WS signals need to be present for the clock to operate correctly.

[3] This parameter is not tested during production; the value is guaranteed by design and checked during product validation.

[4] When the PLL is locked on BCK, amplifier output noise can deteriorate when clock jitter >1 ns; performance is guaranteed up to jitter = 2 ns.

[5] The system is less sensitive to jitter when the PLL is locked on FS.

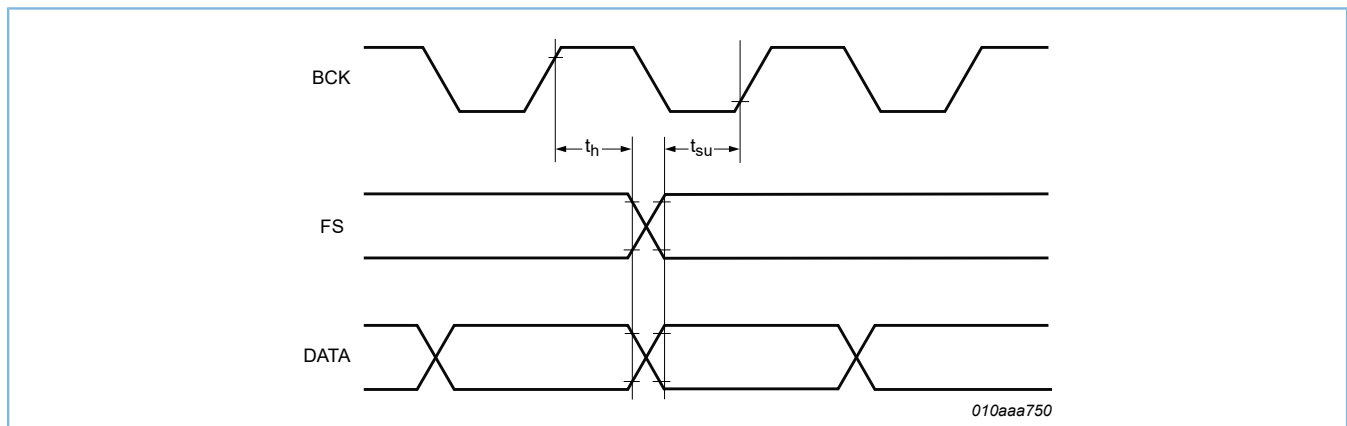

Figure 11-1: TDM timing

11.4 I²C timing characteristics

Table 11-4: I²C-bus interface characteristics

All parameters are guaranteed for $V_{BAT} = 4.0\text{ V}$; $V_{DDD} = 1.8\text{ V}$; $V_{DDP} = V_{BST} = 8.5\text{ V}$, adaptive boost mode; $L_{BST} = 1\ \mu\text{H}$ ^[1]; $R_L = 8\ \Omega$ ^[1]; $L_L = 44\ \mu\text{H}$ ^[1]; $f_i = 1\text{ kHz}$; $f_s = 48\text{ kHz}$; $T_{amb} = 25\text{ }^\circ\text{C}$; default settings, unless otherwise specified.

Symbol	Parameter	Conditions	Min	Typ	Max	Unit
f_{SCL}	SCL clock frequency		-	-	400	kHz
t_{LOW}	LOW period of the SCL clock		1.3	-	-	μs
t_{HIGH}	HIGH period of the SCL clock		0.6	-	-	μs
t_r	rise time	SDA and SCL signals	^[2] $20 + 0.1 C_b$	-	-	ns
t_f	fall time	SDA and SCL signals	^[2] $20 + 0.1 C_b$	-	-	ns

Symbol	Parameter	Conditions	Min	Typ	Max	Unit
$t_{HD;STA}$	hold time (repeated) START condition		[3] 0.6	-	-	μs
$t_{SU;STA}$	set-up time for a repeated START condition		0.6	-	-	μs
$t_{SU;STO}$	set-up time for STOP condition		0.6	-	-	μs
t_{BUF}	bus free time between a STOP and START condition		1.3	-	-	μs
$t_{SU;DAT}$	data set-up time		100	-	-	ns
$t_{HD;DAT}$	data hold time		0	-	-	μs
t_{SP}	pulse width of spikes that must be suppressed by the input filter		[4] 0	-	50	ns
C_b	capacitive load for each bus line		-	-	400	pF

- [1] L_{BST} = boost converter inductance; R_L = load resistance; L_L = load inductance (speaker).
- [2] C_b is the total capacitance of one bus line in pF. The maximum capacitive load for each bus line is 400 pF.
- [3] After this period, the first clock pulse is generated.
- [4] To be suppressed by the input filter.

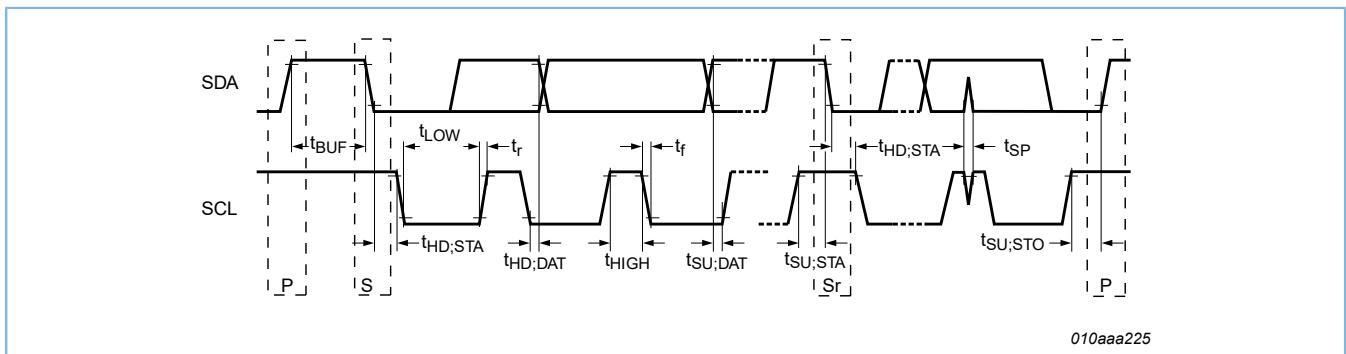

Figure 11-2: I²C timing

12 Application information

12.1 Application diagrams

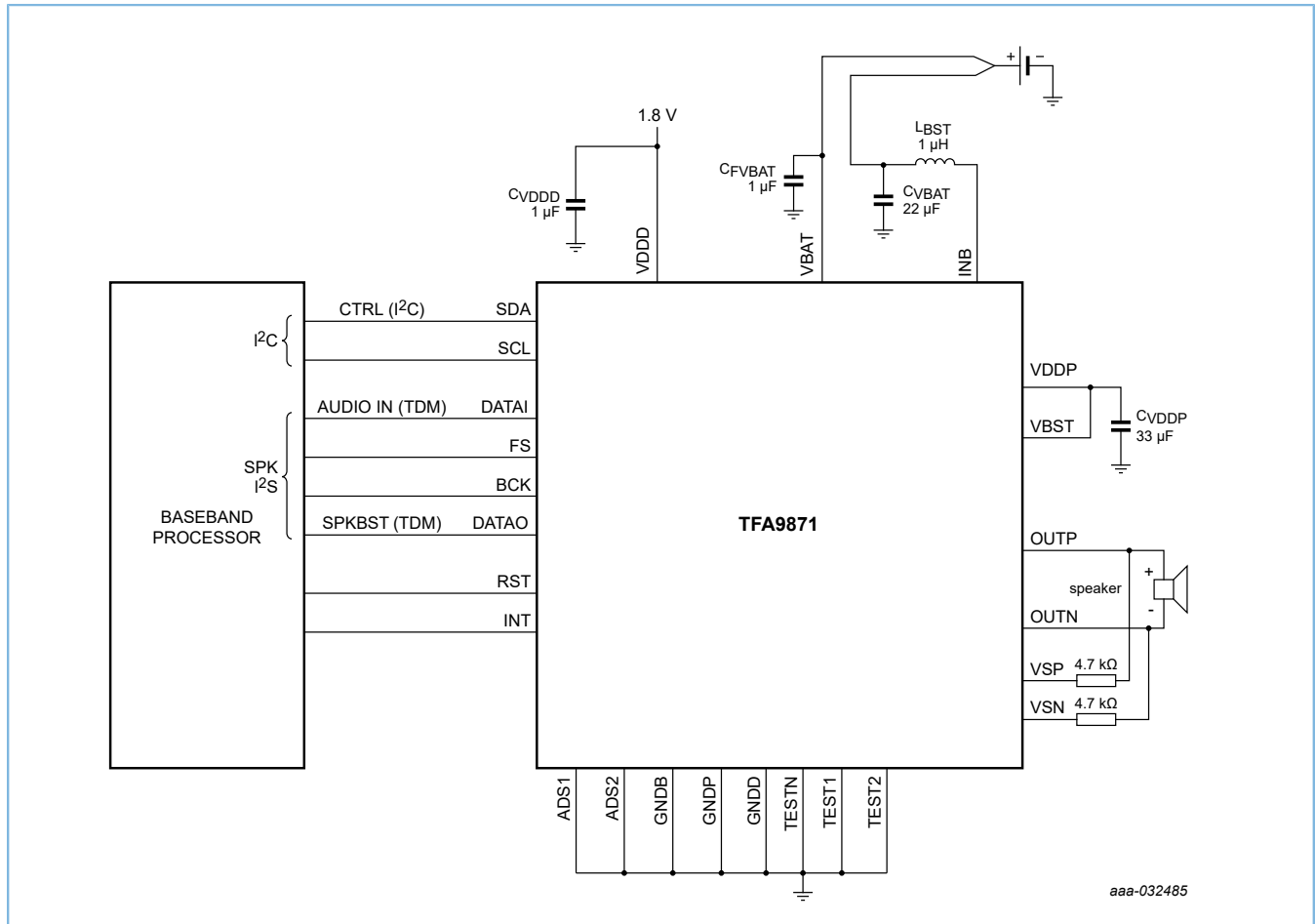

Figure 12-1: Typical mono application

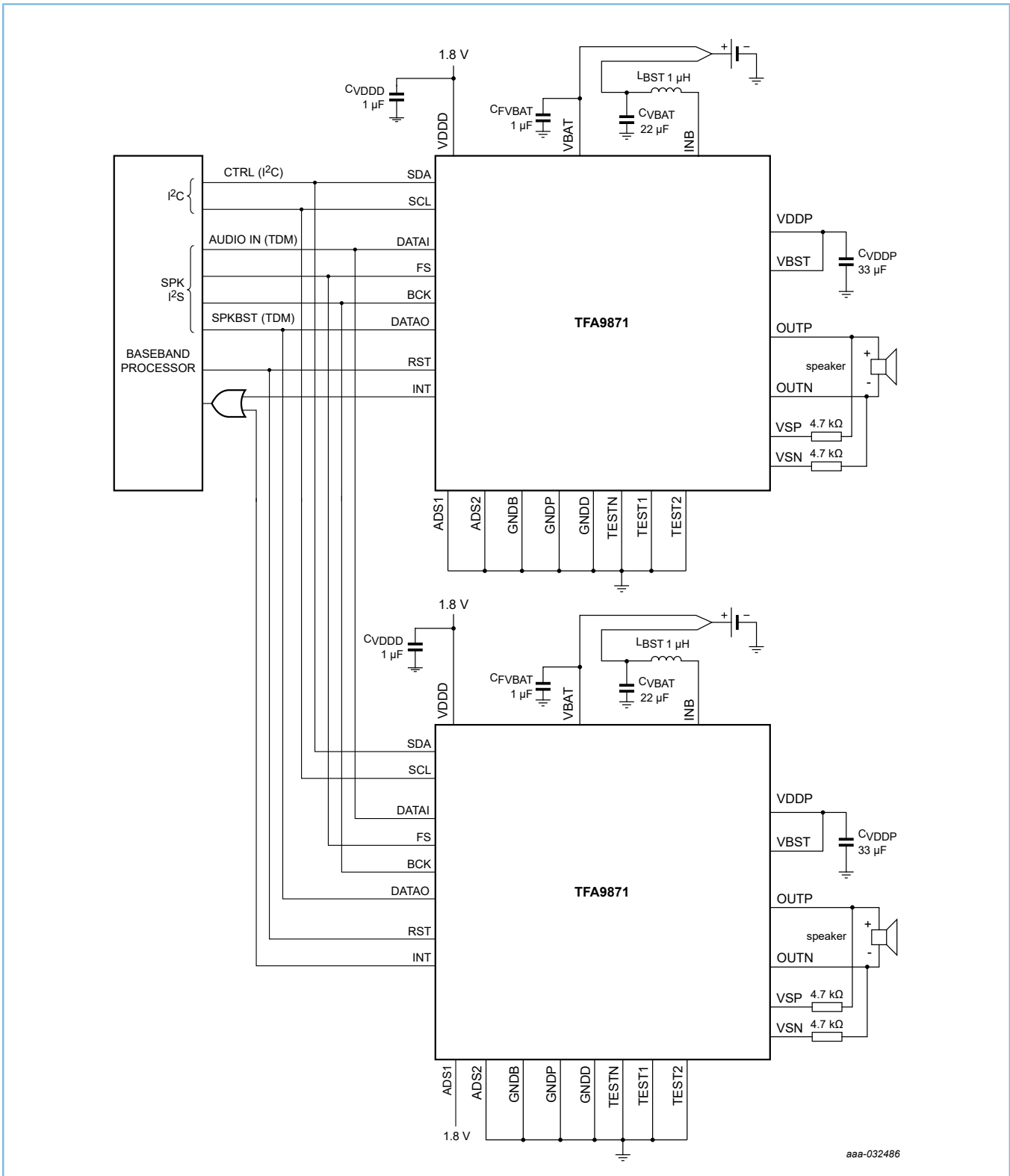

Figure 12-2: Typical stereo application

13 Package outline

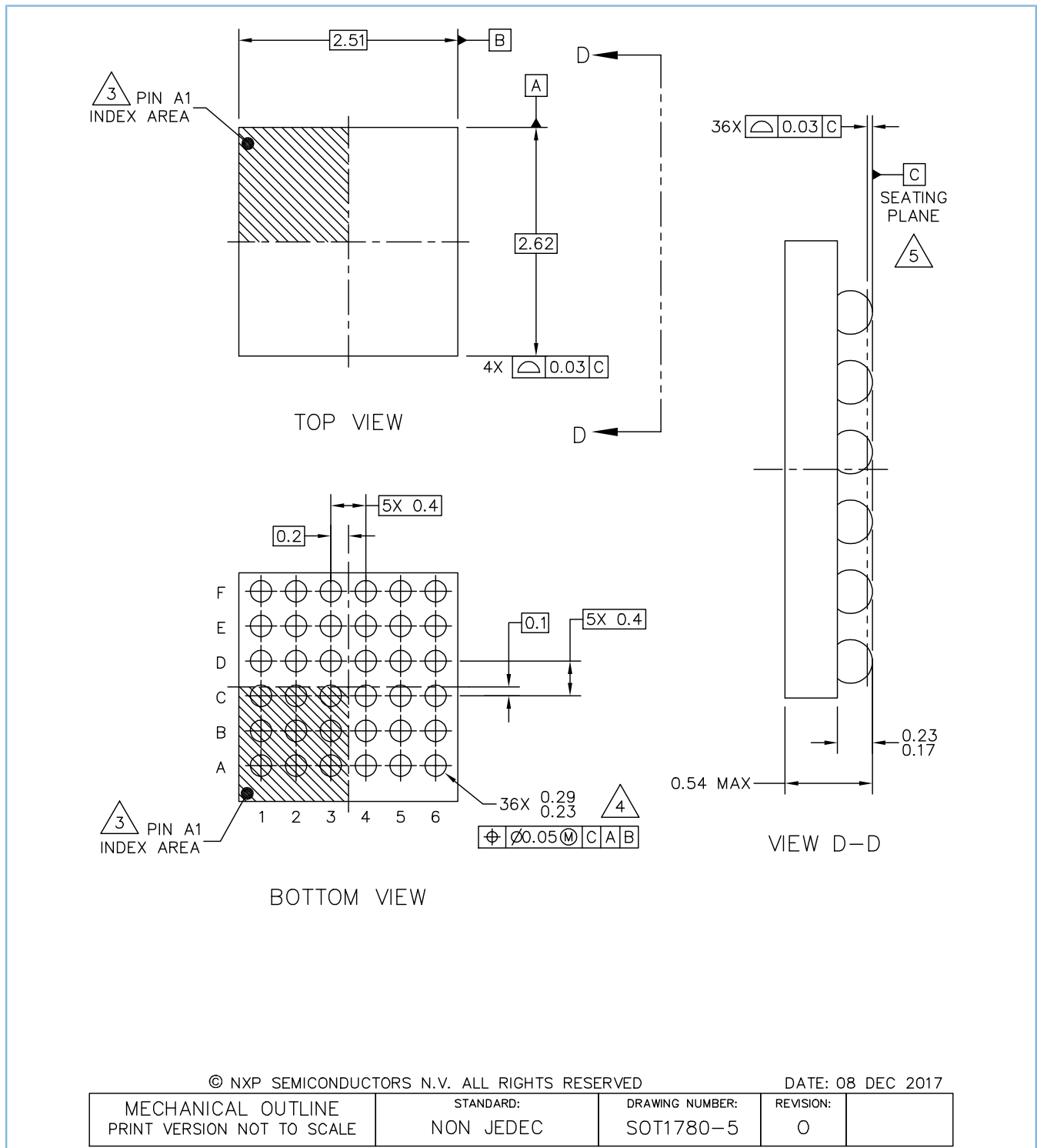

Figure 13-1: Package outline WLCSP36 (SOT1780-5); no back side coating

14 Soldering of WLCSP packages

14.1 Introduction to soldering WLCSP packages

This text provides a very brief insight into a complex technology. More information about handling, packing, shipping and soldering of moisture/reflow sensitive surface-mount devices can be found in IPC/JEDEC J-STD-033 and IPC/JEDEC J-STD-020.

Wave soldering is not suitable for this package.

All Goodix WLCSP packages are lead-free.

14.2 Board mounting

Board mounting of a WLCSP requires several steps:

1. Solder paste printing on the PCB
2. Component placement with a pick and place machine
3. The reflow soldering itself

14.3 Reflow soldering

Key characteristics in reflow soldering are:

- Lead-free versus SnPb soldering; note that a lead-free reflow process usually leads to higher minimum peak temperatures (see [Figure 14-1](#)) than a SnPb process, thus reducing the process window
- Solder paste printing issues, such as smearing, release, and adjusting the process window for a mix of large and small components on one board
- Reflow temperature profile; this profile includes preheat, reflow (in which the board is heated to the peak temperature), and cooling down. It is imperative that the peak temperature is high enough for the solder to make reliable solder joints (a solder paste characteristic) while being low enough that the packages and/or boards are not damaged. The peak temperature of the package depends on package thickness and volume and is classified in accordance with [Table 14-1](#).

Table 14-1: Lead-free process (from J-STD-020D)

Package thickness (mm)	Package reflow temperature (°C)		
	Volume (mm ³)		
	< 350	350 to 2 000	> 2 000
< 1.6	260	260	260
1.6 to 2.5	260	250	245
> 2.5	250	245	245

Moisture sensitivity precautions, as indicated on the packing, must be respected at all times.

Studies have shown that small packages reach higher temperatures during reflow soldering, see [Figure 14-1](#).

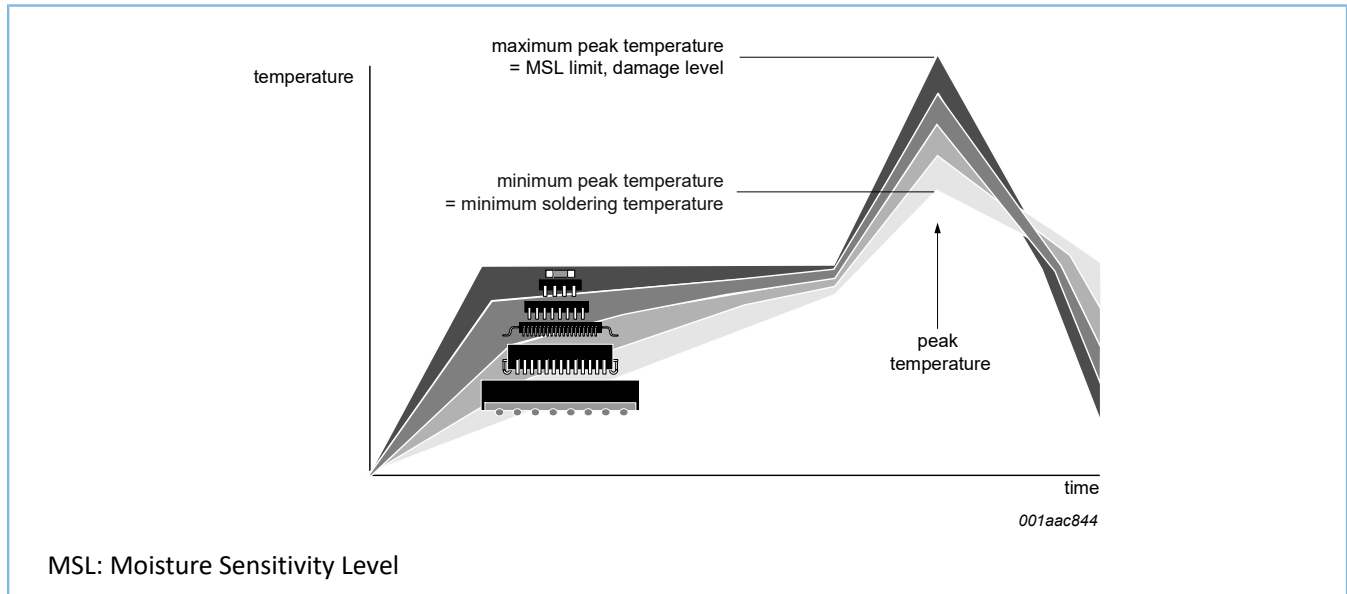

Figure 14-1: Temperature profiles for large and small components

For further information on temperature profiles, refer to IPC/JEDEC J-STD-033 and IPC/JEDEC J-STD-020.

14.3.1 Stand off

The stand off between the substrate and the chip is determined by:

- The amount of printed solder on the substrate
- The size of the solder land on the substrate
- The bump height on the chip

The higher the stand off, the better the stresses are released due to TEC (Thermal Expansion Coefficient) differences between substrate and chip.

14.3.2 Quality of solder joint

A flip-chip joint is considered to be a good joint when the entire solder land has been wetted by the solder from the bump. The surface of the joint should be smooth and the shape symmetrical. The soldered joints on a chip should be uniform. Voids in the bumps after reflow can occur during the reflow process in bumps with high ratio of bump diameter to bump height, i.e. low bumps with large diameter. No failures have been found to be related to these voids. Solder joint inspection after reflow can be done with X-ray to monitor defects such as bridging, open circuits and voids.

14.3.3 Rework

In general, rework is not recommended. By rework we mean the process of removing the chip from the substrate and replacing it with a new chip. If a chip is removed from the substrate, most solder balls of the chip will be damaged. In that case it is recommended not to re-use the chip again.

Device removal can be done when the substrate is heated until it is certain that all solder joints are molten. The chip can then be carefully removed from the substrate without damaging the tracks and solder lands on the substrate. Removing the device must be done using plastic tweezers, because metal tweezers can damage the silicon. The surface of the substrate should be carefully cleaned and all solder and flux residues and/or underfill removed. When a new chip is placed on the substrate, use the flux process instead of solder on the solder lands. Apply flux on the bumps at the chip side as well as on the solder pads on the substrate. Place and align the new chip while viewing with a microscope. To reflow the solder, use the solder profile shown in IPC/JEDEC J-STD-033 and IPC/JEDEC J-STD-020.

14.3.4 Cleaning

Cleaning can be done after reflow soldering.

15 Legal and contact information

Copyright © 2020 Shenzhen Goodix Technology Co., Ltd. All rights reserved.

Any excerption, backup, modification, translation, transmission or commercial use of this document or any portion of this document, in any form or by any means, without the prior written consent of Shenzhen Goodix Technology Co., Ltd is prohibited.

Trademarks and Permissions

GOODiX and other Goodix trademarks are trademarks of Shenzhen Goodix Technology Co., Ltd. All other trademarks and trade names mentioned in this document are the property of their respective holders.

Disclaimer

Information contained in this document is intended for your convenience only and is subject to change without prior notice. It is your responsibility to ensure its application complies with technical specifications.

Shenzhen Goodix Technology Co., Ltd. (hereafter referred to as “Goodix”) makes no representation or guarantee for this information, express or implied, oral or written, statutory or otherwise, including but not limited to representation or guarantee for its application, quality, performance, merchantability or fitness for a particular purpose. Goodix shall assume no responsibility for this information and relevant consequences arising out of the use of such information.

Without written consent of Goodix, it is prohibited to use Goodix products as critical components in any life support system. Under the protection of Goodix intellectual property rights, no license may be transferred implicitly or by any other means.

Shenzhen Goodix Technology Co., Ltd.

Headquarters: Floor 13, Tower B, Tengfei Industrial Building, Futian Free Trade Zone, Shenzhen, China

TEL: +86-755-33338828 FAX: +86-755-33338830

Website: www.goodix.com

16 Revision history

Table 16-1: Revision history

Document ID	Release date	Data sheet status	Change notice	Supersedes
TFA9871_SDS v 2.0	20200121	Product short data sheet	-	TFA9871_SDS v.1.1
Modifications:	<ul style="list-style-type: none"> Updated document format based on Goodix template 			
TFA9871_SDS v.1.1	<Tbd>	Product short data sheet	-	TFA9871_SDS v.1
Modifications:	<ul style="list-style-type: none"> Section 12.1 "Application diagrams" has been updated. 			
TFA9871_SDS v.1	20180427	Product short data sheet	-	-